

# FlowCon FH Actuators

*FlowCon Electrical Actuators*



## SPECIFICATIONS

### **FlowCon FH.0.2**

Supply voltage:	24V AC/DC $\pm 10\%$ , 50/60 Hz
Type:	Electrical, Bi-directional synchronous motor
Power consumption:	7VA
Control signal:	Analog 0(2)-10V DC
Feedback:	Yes, 0(2)-10V DC
Failsafe function:	No
Autostroke:	Optional
Operation time:	50 Hz: 28 sec/mm
Actuating force:	Extra high
Ambient temperature:	+2°C to +50°C
Humidity rating:	<95% no condensation
Protection:	IP54, class II
Cable:	Fixed, 4 wires 22 AWG halogen free cable, 1 meter
Closing point adjustment:	During operation the actuator will self-adjust according to the closing point of the valve.

## SPECIFICATIONS (...continued)

### FlowCon FH.0.4

Supply voltage:	24V AC/DC $\pm$ 10%, 50/60 Hz
Type:	Electrical, Bi-directional synchronous motor
Power consumption:	7VA
Control signal:	Digital (2-position / 3-point-floating)
Feedback:	No
Failsafe function:	No
Operation time:	50 Hz: 28 sec/mm
Actuating force:	Extra high
Ambient temperature:	+2°C to +50°C
Humidity rating:	<95% no condensation
Protection:	IP54, class II
Cable:	Fixed, 3 wires 22 AWG halogen free cable, 1 meter
Closing point adjustment:	During operation the actuator will self-adjust according to the closing point of the valve.

### FlowCon FH.1.2

Supply voltage:	24V AC/DC $\pm$ 10%, 50/60 Hz
Type:	Electrical, Bi-directional synchronous motor
Power consumption:	9VA
Control signal:	Analog 0(2)-10V DC
Feedback:	Yes, 0(2)-10V DC
Failsafe function:	Yes, optional open or close
Autostroke:	Optional
Operation time:	50 Hz: 28 sec/mm
Actuating force:	Extra high
Ambient temperature:	+2°C to +50°C
Humidity rating:	<95% no condensation
Protection:	IP54, class II
Cable:	Fixed, 4 wires 22 AWG halogen free cable, 1 meter
Closing point adjustment:	During operation the actuator will self-adjust according to the closing point of the valve.

### FlowCon FH.1.4

Supply voltage:	24V AC/DC $\pm$ 10%, 50/60 Hz
Type:	Electrical, Bi-directional synchronous motor
Power consumption:	9VA
Control signal:	Digital (2-position / 3-point-floating)
Feedback:	No
Failsafe function:	Yes, optional open or close
Operation time:	50 Hz: 28 sec/mm
Actuating force:	Extra high
Ambient temperature:	+2°C to +50°C
Humidity rating:	<95% no condensation
Protection:	IP54, class II
Cable:	Fixed, 4 wires 22 AWG halogen free cable, 1 meter
Closing point adjustment:	During operation the actuator will self-adjust according to the closing point of the valve.

## DIMENSIONS AND WEIGHTS (NOMINAL) (measured in mm unless noted)

Actuator	L	W	H1	H2	T	Weight (kgs.)
FH.0.X	104	51	92	-	M30x1.5	0.25
FH.1.X			-	107		0.30

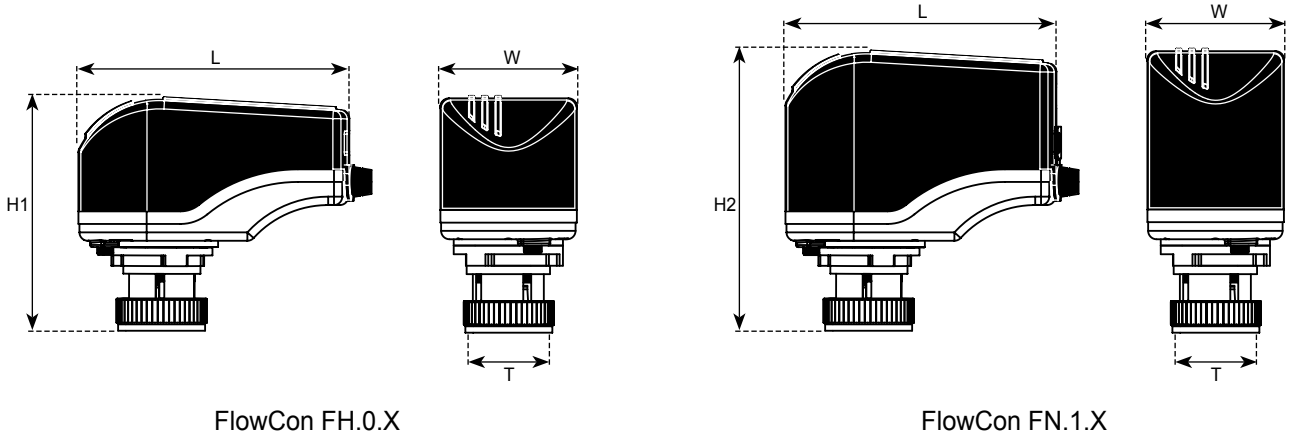

## MODEL NUMBER SELECTION

Insert actuating force and failsafe function:

- 0**=Extra high (no failsafe)
- 1**=Extra high and failsafe

Insert control mode:

- 2**=24V modulating
- 4**=24V 2-position / 3-point-floating

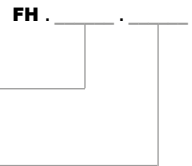

Example: FH.0.2=FlowCon FH actuator 24V modulating, extra high actuating force without failsafe function.

## WIRING INSTRUCTION

### FlowCon FH.0.2 and FH.1.2

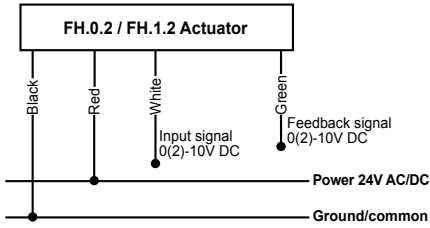

### FlowCon FH.0.4

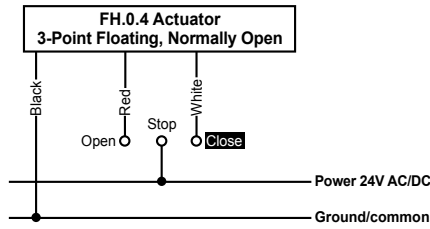
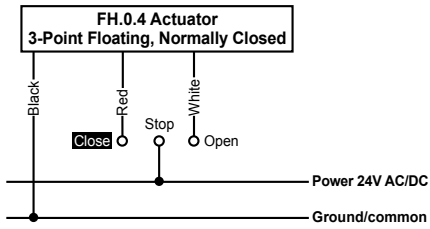
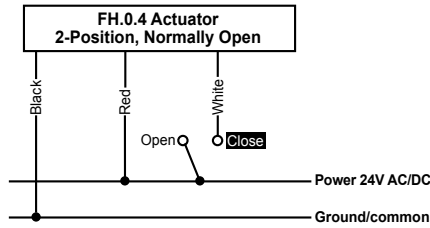
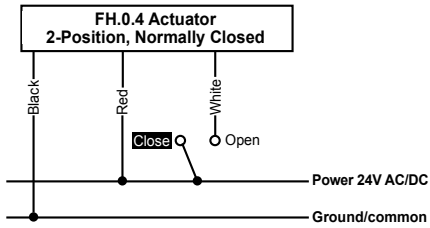

### FlowCon FH.1.4

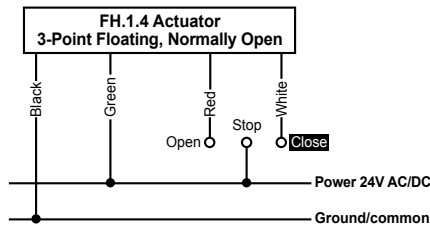
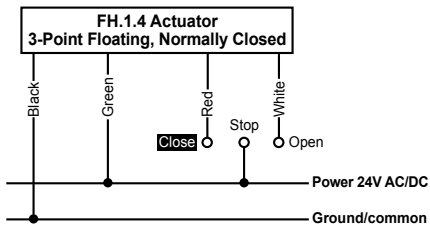
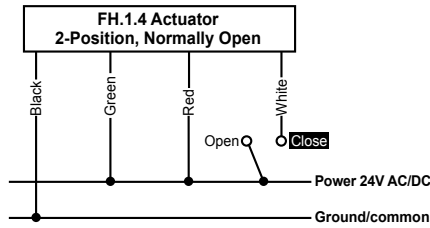
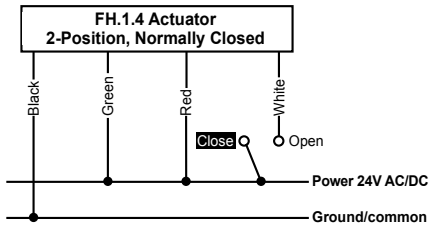

## UPDATES

For latest updates please see [www.flowcon.com](http://www.flowcon.com)

FlowCon International can accept no responsibility for possible errors in any printed material. All rights reserved.